

# Rosemount™ 248 Temperature Transmitter



- Basic temperature transmitter offers a reliable solution for temperature monitoring points.
- Standard transmitter design provides flexible and reliable performance in process environments.
- Experience lower overall installation costs when compared to wiring sensor directly, reducing the need for expensive extension wires and multiplexers.
- Explore the benefits of a Complete Point Solution™ from Rosemount Temperature.

## Features and benefits

- RTD, TC, potentiometer, linear resistance and bipolar mV input
- Wide ambient operating temperature of -50 to +85 °C
- 2.5 kVAC galvanic isolation

## Basic temperature transmitter offers a cost effective solution for temperature monitoring points

- DIN B style head mount transmitter
- Variety of DIN B enclosure options
- HART®/4–20 mA Protocol
- Single sensor capability with universal sensor inputs (RTD, T/C, mV, ohms)
- Transmitter-sensor matching with Callendar Van Dusen constants
- SIL2 Capable: IEC 61508 certified by an accredited third party agency for use in safety instrumented systems up to SIL 2



## Standard transmitter design provides flexible and reliable performance in process environments

- Offers improved measurement accuracy and reliability over direct-wiring a sensor to the digital control system for a lower overall installation cost
- One-year stability rating reduces maintenance costs
- Open/short sensor diagnostics assist with detecting issues in the sensor loop
- Compensation for ambient temperatures enhances transmitter performance

---

### Contents

Features and benefits.....	2
Ordering information.....	5
Transmitter specifications.....	10
Product certifications.....	19
Dimensional drawings.....	32
Configuration interface specifications.....	33

## Explore the benefits of a complete point solution from Rosemount Temperature Measurement

- An “Assemble To Sensor” option enables Emerson to provide a complete point temperature solution, delivering an installation-ready transmitter, and sensor assembly.
- Emerson offers a selection of RTDs, thermocouples, and thermowells that bring superior durability and Rosemount reliability to temperature sensing, complementing the Rosemount Transmitter portfolio.

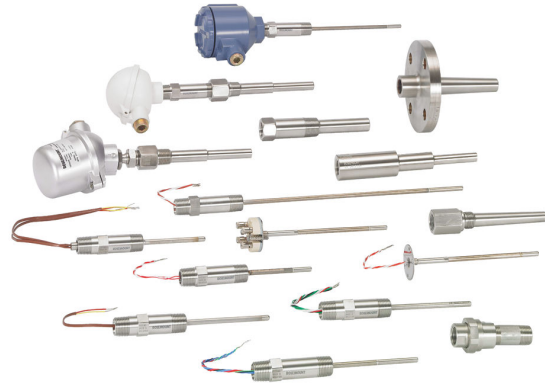

## Experience global consistency and local support from numerous worldwide Rosemount Temperature manufacturing sites



- Experienced Instrumentation Consultants help select the right product for any temperature application and advise on best installation practices
- An extensive global network of Emerson service and support personnel can be onsite when and where they are needed
- World-class manufacturing provides globally consistent product from every factory and the capacity to fulfill the needs of any project, large or small

## Access information when you need it with asset tags

Newly shipped devices include a unique QR code asset tag that enables you to access serialized information directly from the device. With this capability, you can:

- Access device drawings, diagrams, technical documentation, and troubleshooting information in your MyEmerson account
- Improve mean time to repair and maintain efficiency
- Ensure confidence that you have located the correct device
- Eliminate the time-consuming process of locating and transcribing nameplates to view asset information



## Required model components

### Model

Code	Description	
248	Temperature transmitter	★

### Transmitter type

Code	Description	
H	DIN B head mount	★

### Transmitter output

Code	Description	
A	4–20 mA with digital signal based on HART® Protocol	★

### Product certifications

Code	Description		
E5	USA Explosion-Proof	A, G, H, J, K, U	★
I5	USA Intrinsic Safety and Class I, Division 2	A, B, G, H, J, K, N, U	★
K5	USA Intrinsic Safety, Explosion-Proof, and Class I, Division 2	A, G, H, J, K, U	★
I6	Canada Intrinsic Safety and Class I, Division 2	A, B, G, H, J, K, N, U	★
K6	Canada Intrinsic Safety, Explosion-Proof, and Class I, Division 2	A, G, H, J, K, U	★
E1	ATEX Flameproof	A, G, H, J, K, U	★
I1	ATEX Intrinsic Safety	All Options	★
ND	ATEX Dust	A, G, H, J, K, U	★
N1	ATEX Zone 2	A, G, H, J, K, U	★
NC <sup>(1)</sup>	ATEX Zone 2 without enclosure	N	★
E7	IECEX Flameproof and Dust	A, G, H, J, K, U	★
I7	IECEX Intrinsic Safety	All options	★
N7	IECEX Zone 2	A, G, H, J, K, U	★
NG	IECEX Zone 2 without enclosure	N	★
KM	Technical Regulations Customs Union (EAC) Flameproof, Intrinsic Safety	A, G, H, J, K, U	★
IM	Technical Regulations Customs Union (EAC) Intrinsic Safety	All options	★
EM	Technical Regulations Customs Union (EAC) Flameproof	A, G, H, J, K, U	★
EP	Korea Explosionproof/Flameproof	A, G, H, J, K, U	★
E3	China flameproof	A, G, H, J, K, U	★
I3	China intrinsic safety	A, B, G, H, J, K, N, U	★
N3	China type n	A, G, H, J, K, U	★

Code	Description		
NA	No approval	All options	★

(1) *The Rosemount 248H with ATEX Type n Component Approval is not approved as a stand alone unit; additional system certification is required. Transmitter must be installed so it is protected to at least the requirements of IP54.*

### Enclosure

Code	Description	Material	IP rating	
A	Connection head	Aluminum	IP66/68	★
B	BUZ head	Aluminum	IP65	★
C	BUZ head	Polypropylene	IP65	★
G	Connection head	SST	IP66/IP68	★
J	Universal junction box, 3 entries	Aluminum	IP66/IP68	★
K	Universal junction box, 3 entries	SST	IP66/IP68	★
H	Universal head (junction box)	SST	IP66/IP68	★
U	Universal head (junction box)	Aluminum	IP66/IP68	★
N	No enclosure	N/A	N/A	★
F	Sanitary connection head, DIN A	Polished SST	IP66/IP68	
S	Sanitary connection head, DIN B	Polished SST	IP66/IP68	

### Conduit entry size

All process connection threads are ½-in. NPT, except for Enclosure Codes H and U with Conduit Entry Code 1 and Sensor Type Code NS.

Code	Description	
1	M20 × 1.5 (CM20)	★
2	½-in. NPT	★
0	No enclosure	★

### Additional options

#### Assemble to options

Code	Description	
XA	Sensor specified separately and assembled to transmitter	★
NS	No sensor	
XC	Hand tight assembly of a transmitter and sensor	

### Mounting bracket

Code	Description	
B4	Universal mounting bracket for 2-in. pipe and panel mounting - SST bracket and bolts	★
B5	Universal "L" mounting bracket for 2-in. pipe mounting - SST bracket and bolts	★

**Alarm level configuration**

Code	Description	
A1	NAMUR alarm and saturation levels, high alarm	★
CN	NAMUR alarm and saturation levels, low alarm	★

**Five-point calibration**

Code	Description	
C4	5-point calibration (requires the Q4 option code to generate a calibration certificate)	★

**Calibration certification**

Code	Description	
Q4	Calibration certificate (3-point calibration)	★
QG	Calibration certificate and GOST verification certificate	★
QP	Calibration certificate and tamper evident seal	★

**Line filter**

Code	Description	
F6	60 Hz line voltage filter	★

**Sensor trim**

Code	Description	
C2 <sup>(1)</sup>	Transmitter sensor matching - trim to specific Rosemount RTD calibration schedule (C-VD constants)	★

(1) Requires HR7 (HART Revision 7).

**Quality certification for safety**

Code	Description	
QT	Safety certified to IEC 61508 with certificate of FMEDA data	★

**Conduit electrical connector**

Available with Intrinsically Safe approvals only for USA Intrinsically Safe or Non-Incendive approval (option code I5). To maintain NEMA® 4X rating, it must be installed according to Rosemount Drawing 03151-1009.

Code	Description	
GE	M12, 4 pin, male connector (eurofast®)	★
GM	A-size mini, 4 pin, male connector (minifast®)	



**External label**

Code	Description	
EL	External label for ATEX Intrinsic Safety	★

**Cable gland**

Code	Description	
G2	Cable gland (7.5–11.99 mm)	★
G4	Thin wire cable gland (3–8 mm)	

**Cover chain**

Code	Description	
G3	Cover chain	★

**Enhanced Performance**

Code	Description	
P8	Enhanced accuracy	★

**Software configuration**

Code	Description	
C1	Custom configuration of date, descriptor, and message (requires <a href="#">Configuration Data Sheet</a> with order)	★

**HART revision configuration**

HART Revision 5 is the default HART output.

Code	Description	
HR5	Configured for HART Revision 5	★
HR7 <sup>(1)</sup>	Configured for HART Revision 7	★

(1) Configures the HART output to HART Revision 7. If needed, the device can be field configured to HART Revision 5.

**Extended product warranty**

Code	Description	
WR3	3-year limited warranty	★
WR5	5-year limited warranty	★

**Cold temperature option**

Code	Description	
BR5	–60 °F (–51 °C) cold temperature option	
BR6	–76 °F (–60 °C) cold temperature option	

# Transmitter specifications

## Functional specifications

### Inputs

User-selectable; sensor terminals rates to 42.4 Vdc. See [Transmitter accuracy and ambient temperature effects](#) for sensor options.

### Output

Two-wire 4–20 mA, linear with temperature or input; digital output signal superimposed on 4–20 mA signal, available for a field communicator or control system interface.

### Isolation

Input/output isolation tested to 500 Vac rms (707 Vdc) at 50/60 Hz.

### Power supply

An external power supply is required for HART devices. The transmitter operates on 12.0 to 42.4 Vdc transmitter terminal voltage with load resistance between 250 and 1100 ohms. A minimum of 17.75 Vdc power supply is required with a load of 250 ohms. Transmitter power terminals are rated to 42.4 Vdc.

**Figure 2: Maximum Load = 40.8 × (Supply Voltage – 12.0)**

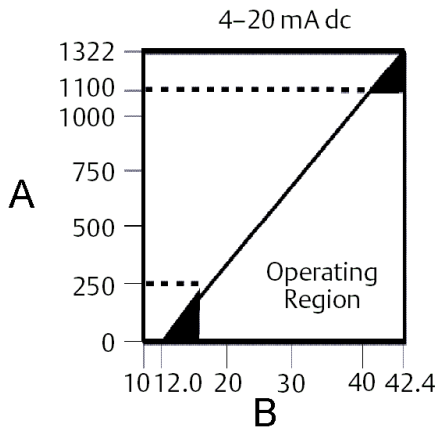

- A. Load (ohms)
- B. Supply voltage (Vdc)

### Humidity limits

0–95% relative humidity, non-condensing

## NAMUR recommendations

The Rosemount 248 meets the following NAMUR recommendations:

- NE 21 – Electromagnetic (EMC) compatibility for Process and Laboratory Apparatus
- NE 43 – Standard of the signal level breakdown information of digital transmitters
- NE 53 – Revision controlled labeling for software and hardware changes
- NE 89 – Standard of temperature transmitters with digital signal processing
- NE 107 – Self-Monitoring and Diagnosis of Field Devices

## Temperature limits

### Operating limit

- -40 to 185 °F (-40 to 85 °C)
- -60 to 185 °F (-50 to 85 °C) available with BR5
- -76 to 185 °F (-60 to 85 °C) available with BR6

### Storage limit

- -58 to 248 °F (-50 to 120 °C)

## Turn-on time

Performance within specifications in less than five seconds after power is applied to transmitter, when damping value is set to zero seconds.

## Update rate

Less than 0.5 seconds

## Damping

32 seconds maximum; five seconds default

## Custom alarm and saturation levels

Custom factory configuration of alarm and saturation levels is available with option code C1 for valid values. These values can also be configured in the field using a field communicator.

## Recommended minimum measuring span

See [Transmitter accuracy and ambient temperature effects](#).

## Software detected failure mode

The values at which the transmitter drives its output in failure mode depends on whether it is configured to standard, custom, or NAMUR-compliant (NAMUR recommendation NE 43) operation. The values for standard and NAMUR-compliant operation are as follows:

**Table 1: Operation Parameters**

	Standard (mA)	NAMUR NE43- compliant (mA)
Linear output	$3.9 \leq I \leq 20.5$	$3.8 \leq I \leq 20.5$
Fail high	$21 \leq I \leq 23$ (default)	$21 \leq I \leq 23$ (default)
Fail low	$I \leq 3.75$	$I \leq 3.6$

Certain hardware failures, such as microprocessor failures, will always drive the output to greater than 23 mA.

## Physical specifications

### Material selection

Emerson provides a variety of Rosemount product with various product options and configurations including materials of construction that can be expected to perform well in a wide range of applications. The Rosemount product information presented is intended as a guide for the purchaser to make an appropriate selection for the application. It is the purchaser's sole responsibility to make a careful analysis of all process parameters (such as all chemical components, temperature, pressure, flow rate, abrasives, contaminants, etc.), when specifying product, materials, options, and components for the particular application. Emerson is not in a position to evaluate or guarantee the compatibility of the process fluid or other process parameters with the product, options, configuration, or materials of construction selected.

### Conformance to specification ( $\pm 3\sigma$ [Sigma])

Technology leadership, advanced manufacturing techniques, and statistical process control ensure specification conformance to at least  $\pm 3\sigma$ .

### Field communicator connections

Communication terminal: clips permanently fixed to the terminals

### Materials of construction

#### Electronics housing

Polyphenylene ether and polystyrene blend. Glass reinforced.

#### Universal (option code G, H, J, and K) and Rosemount connection (option code A and G) heads

- Housing: Low-copper aluminum (option codes A, J, and U)
- Stainless steel (option codes G, H, and K)
- Paint: Polyurethane
- Cover O-Ring: Buna-N

#### BUZ head (option code B)

- Housing: Aluminum
- Paint: Aluminum lacquer

- O-ring seal: Rubber

## Mounting

The Rosemount 248R attaches directly to a wall or a DIN rail. The Rosemount 248H installs in a connection head or universal head mounted directly on a sensor assembly or apart from a sensor assembly using a universal head. The Rosemount 248H can also mount to a DIN rail using an optional mounting clip (see [Options](#)).

## Weight

Code	Options	Weight
248H	Headmount transmitter	50 g (1.7 oz)
U	Universal head	567 g (20.0 oz)
J	Universal junction box, 3 entries aluminum	718 g (25.3 oz)
K	Universal junction box, 3 entries, SST	2073 g (73.1 oz)
B	BUZ head	277 g (9.8 oz)
C	Polypropylene head	89 g (3.1 oz)
A	Rosemount connection head	526 g (18.5 oz)
S	Polished stainless steel (SST) head	740 g (26.1 oz)
G	Rosemount connection head (SST)	1613 g (56.9 oz)
H	Universal head (SST)	1673 g (59.0 oz)

## Enclosure ratings

The universal (option code U) and Rosemount connection (option code A) heads are NEMA 4X, IP66, and IP68. The universal head with ½ NPT threads is CSA Enclosure Type 4X. The BUZ head (option code B) is NEMA 4 and IP65.

## Performance specifications

### Electromagnetic compatibility (EMC)

Meets all industrial environment requirements of EN61326 and NAMUR NE-21. Maximum deviation < 1% span during EMC disturbance.

### Power supply effect

Less than ±0.005% of span per volt

### Vibration effect

Tested to the following with no effect on performance per IEC 60770-1, 2010:

Frequency	Vibration
10 to 60 Hz	0.35 mm displacement
60 to 2000 Hz	5g peak acceleration

### Stability

For RTD and thermocouple inputs the transmitter will have a stability of  $\pm 0.1\%$  of reading or  $0.1\text{ }^{\circ}\text{C}$  (whichever is greater) for 12 months.

### Self calibration

The analog-to-digital measurement circuitry automatically self-calibrates for each temperature update by comparing the dynamic measurement to extremely stable and accurate internal reference elements.

### Sensor connections

Figure 3: Rosemount 248 Sensor Connections

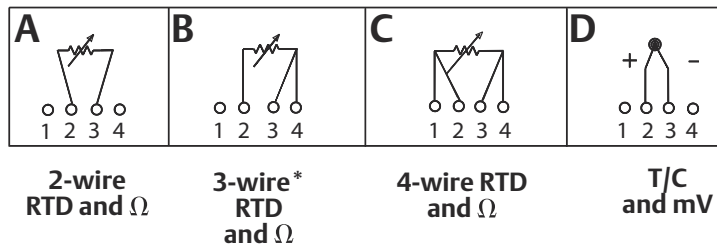

- A. 2-wire RTD and  $\Omega$
- B. 3-wire RTD and  $\Omega$

**Note**

Rosemount provides four-wire sensors for all single element RTDs. These RTDs can be used in three-wire configurations by leaving the unneeded leads disconnected and insulated with electrical tape.

- C. 4-wire RTD and  $\Omega$
- D. T/C and mV

### Transmitter accuracy and ambient temperature effects

**Note**

The accuracy and ambient temperature effect is the greater of the fixed and percent of span values (see example).

Table 2: Rosemount 248 Transmitter Accuracy

Sensor options	Sensor reference	Input ranges		Recommended min. span <sup>(1)</sup>		Accuracy <sup>(2)</sup>		
						Fixed		% of span
2-, 3-, 4-wire RTDs		$^{\circ}\text{C}$	$^{\circ}\text{F}$	$^{\circ}\text{C}$	$^{\circ}\text{F}$	$^{\circ}\text{C}$	$^{\circ}\text{F}$	
Pt 100 ( $\alpha = 0.00385$ )	IEC 751	-200 to 850	-328 to 1562	10	18	$\pm 0.15$	$\pm 0.27$	$\pm 0.10\%$
Pt 100 ( $\alpha = 0.00385$ ) Enhanced accuracy	IEC 751	-200 to 850	-328 to 1562	10	18	$\pm 0.1$	$\pm 0.18$	$\pm 0.10\%$
Pt 200 ( $\alpha = 0.00385$ )	IEC 751	-200 to 850	-328 to 1562	10	18	$\pm 0.44$	$\pm 0.79$	$\pm 0.10\%$
Pt 500 ( $\alpha = 0.00385$ )	IEC 751	-200 to 850	-328 to 1562	10	18	$\pm 0.28$	$\pm 0.50$	$\pm 0.10\%$
Pt 1000 ( $\alpha = 0.00385$ )	IEC 751	-200 to 300	-328 to 572	10	18	$\pm 0.23$	$\pm 0.41$	$\pm 0.10\%$
Pt 100 ( $\alpha = 0.003916$ )	JIS 1604	-200 to 645	-328 to 1193	10	18	$\pm 0.20$	$\pm 0.36$	$\pm 0.10\%$
Pt 200 ( $\alpha = 0.003916$ ) <sup>(3)</sup>	JIS 1604	-200 to 645	-328 to 1193	10	18	$\pm 0.44$	$\pm 0.79$	$\pm 0.10\%$
Ni 120	Edison Curve No. 7	-70 to 300	-94 to 572	10	18	$\pm 0.16$	$\pm 0.29$	$\pm 0.10\%$

Table 2: Rosemount 248 Transmitter Accuracy (continued)

Sensor options	Sensor reference	Input ranges		Recommended min. span <sup>(1)</sup>		Accuracy <sup>(2)</sup>		
						Fixed		% of span
2-, 3-, 4-wire RTDs		°C	°F	°C	°F	°C	°F	
Cu 10	Edison Copper Winding No. 15	-50 to 250	-58 to 482	10	18	± 2.00	± 3.60	±0.10%
Pt 50 ( $\alpha = 0.00391$ )	GOST 6651-94	-200 to 550	-328 to 1022	10	18	± 0.40	± 0.72	±0.10%
Pt 100 ( $\alpha = 0.00391$ )	GOST 6651-94	-200 to 550	-328 to 1022	10	18	± 0.20	± 0.36	±0.10%
Cu 50 ( $\alpha = 0.00426$ )	GOST 6651-94	-50 to 200	-58 to 392	10	18	± 0.68	± 1.22	±0.10%
Cu 50 ( $\alpha = 0.00428$ )	GOST 6651-94	-185 to 200	-301 to 392	10	18	± 0.68	± 1.22	±0.10%
Cu 100 ( $\alpha = 0.00426$ )	GOST 6651-94	-50 to 200	-58 to 392	10	18	± 0.34	± 0.61	±0.10%
Cu 100 ( $\alpha = 0.00428$ )	GOST 6651-94	-185 to 200	-301 to 392	10	18	± 0.34	± 0.61	±0.10% of span
<b>Thermocouples<sup>(4)</sup></b>								
Type B <sup>(5)</sup>	NIST Monograph 175	100 to 1820	212 to 3308	25	45	± 1.50	± 2.70	±0.10%
Type E	NIST Monograph 175	-200 to 1000	-328 to 1832	25	45	± 0.40	± 0.72	±0.10%
Type J	NIST Monograph 175	-180 to 760	-292 to 1400	25	45	± 0.50	± 0.90	±0.10%
Type K <sup>(6)</sup>	NIST Monograph 175	-180 to 1372	-292 to 2501	25	45	± 0.50	± 0.90	±0.10%
Type N	NIST Monograph 175	-200 to 1300	-328 to 2372	25	45	± 0.80	± 1.44	±0.10%
Type R	NIST Monograph 175	0 to 1768	32 to 3214	25	45	± 1.20	± 2.16	±0.10%
Type S	NIST Monograph 175	0 to 1768	32 to 3214	25	45	± 1.00	± 1.80	±0.10%
Type T	NIST Monograph 175	-200 to 400	-328 to 752	25	45	± 0.50	± 0.90	±0.10%
Type L	DIN 43710	-200 to 900	-328 to 1652	25	45	± 0.70	± 1.26	±0.10%
Type U	DIN 43710	-200 to 600	-328 to 1112	25	45	± 0.70	± 1.26	±0.10%
Type C	W5Re/W26Re ASTM E988-96	0 to 2000	32 to 3632	25	45	± 1.40	± 2.52	±0.10%
Type L	GOST R 8.585-2001	-200 to 800	-328 to 1472	25	45	± 0.50	± 0.90	±0.10%
<b>Other input types</b>								
Millivolt input		-10 to 100 mV		3mV		± 0.03 mV		±0.10%
2-, 3-, 4-wire ohm input		0 to 2000 ohms		20 ohms		± 0.70 ohm		±0.10%

- (1) No minimum or maximum span restrictions within the input ranges. Recommended minimum span will hold noise within accuracy specification with damping at zero seconds.
- (2) The published digital accuracy applies over the entire sensor input range. Digital output can be accessed by HART Communications or Rosemount control system.
- (3) Pt 200 ( $\alpha = 0.003916$ ) is supported only in HART 7 mode and cannot be configured or used in HART 5 mode.
- (4) Total digital accuracy for thermocouple measurement: sum of digital accuracy +0.5 °C (cold junction accuracy).
- (5) Digital accuracy for NIST Type B T/C is  $\pm 3.0$  °C ( $\pm 5.4$  °F) from 100 to 300 °C (212 to 572 °F).
- (6) Digital accuracy for NIST Type K T/C is  $\pm 0.70$  °C ( $\pm 1.26$  °F) from -180 to -90 °C (-292 to -130 °F).

### Transmitter accuracy example

When using a Pt 100 ( $\alpha = 0.00385$ ) sensor input with a 0 to 100 °C span, use the greater of the two calculated values. In this case, the accuracy would be  $\pm 0.15$  °C.

**Table 3: Ambient Temperature Effect**

Sensor options	Sensor reference	Input ranges		Temperature effects per 1.0 °C (1.8 °F) change in ambient temperature <sup>(1) (2) (3)</sup>		
				Fixed		% of span
2-, 3-, 4-wire RTDs		°C	°F	°C	°F	
Pt 100 ( $\alpha = 0.00385$ )	IEC 751	-200 to 850	-328 to 1562	0.006	0.011	0.004%
Pt 200 ( $\alpha = 0.00385$ )	IEC 751	-200 to 850	-328 to 1562	0.018	0.032	0.004%
Pt 500 ( $\alpha = 0.00385$ )	IEC 751	-200 to 850	-328 to 1562	0.018	0.032	0.004%
Pt 1000 ( $\alpha = 0.00385$ )	IEC 751	-200 to 300	-328 to 572	0.010	0.018	0.004%
Pt 100 ( $\alpha = 0.003916$ )	JIS 1604	-200 to 645	-328 to 1193	0.006	0.011	0.004%
Pt 200 ( $\alpha = 0.003916$ )	JIS 1604	-200 to 645	-328 to 1193	0.018	0.032	0.004%
Ni 120	Edison Curve No. 7	-70 to 300	-94 to 572	0.004	0.007	0.004%
Cu 10	Edison Copper Winding No. 15	-50 to 250	-58 to 482	0.060	0.108	0.004%
Pt 50 ( $\alpha = 0.00391$ )	GOST 6651-94	-200 to 550	-328 to 1022	0.012	0.022	0.004%
Pt 100 ( $\alpha = 0.00391$ )	GOST 6651-94	-200 to 550	-328 to 1022	0.006	0.011	0.004%
Cu 50 ( $\alpha = 0.00426$ )	GOST 6651-94	-50 to 200	-58 to 392	0.012	0.022	0.004%
Cu 50 ( $\alpha = 0.00428$ )	GOST 6651-94	-185 to 200	-301 to 392	0.012	0.022	0.004%
Cu 100 ( $\alpha = 0.00426$ )	GOST 6651-94	-50 to 200	-58 to 392	0.006	0.011	0.004%
Cu 100 ( $\alpha = 0.00428$ )	GOST 6651-94	-185 to 200	-301 to 392	0.006	0.011	0.004%
<b>Thermocouples</b>						
Type B	NIST Monograph 175	100 to 1820	212 to 3308	0.056	0.101	0.004%
Type E	NIST Monograph 175	-200 to 1000	-328 to 1832	0.016	0.029	0.004%
Type J	NIST Monograph 175	-180 to 760	-292 to 1400	0.016	0.029	0.004%
Type K	NIST Monograph 175	-180 to 1372	-292 to 2501	0.020	0.036	0.004%



**Table 3: Ambient Temperature Effect (continued)**

Sensor options	Sensor reference	Input ranges		Temperature effects per 1.0 °C (1.8 °F) change in ambient temperature <sup>(1) (2) (3)</sup>		
				Fixed		% of span
2-, 3-, 4-wire RTDs		°C	°F	°C	°F	
Type N	NIST Monograph 175	-200 to 1300	-328 to 2372	0.020	0.036	0.004%
Type R	NIST Monograph 175	0 to 1768	32 to 3214	0.060	0.108	0.004% of span
Type S	NIST Monograph 175	0 to 1768	32 to 3214	0.060	0.108	0.004%
Type T	NIST Monograph 175	-200 to 400	-328 to 752	0.020	0.036	0.004%
Type L	DIN 43710	-200 to 900	-328 to 1652	0.022	0.040	0.004%
Type U	DIN 43710	-200 to 600	-328 to 1112	0.026	0.047	0.004%
Type C	W5Re/W26Re ASTM E988-96	0 to 2000	32 to 3632	0.064	0.115	0.004%
Type L	GOST R 8.585-2001	-200 to 800	-328 to 1472	0.026	0.047	0.004%
<b>Other input types</b>						
Millivolt Input		-10 to 100 mV		0.001mV		0.004%
2-, 3-, 4-wire Ohm Input		0 to 2000 ohms		0.028 ohms		0.004%

(1) Change in ambient is with reference to the calibration temperature of the transmitter 68 °F (20 °C) from factory.

(2) Ambient temperature effect specification valid over minimum temperature span of 50 °F (28 °C).

(3) Temperature effects (change / °C) are not intended to limit the change in errors in any one degree. They are intended to serve in defining a "butterfly" error band over the full ambient temperature range. This includes the errors defined by "Accuracy" at the narrowest point (room temperature).

### Temperature effects example

Transmitters can be installed in locations where the ambient temperature is between -40 and 185 °F (-40 and 85 °C). In order to maintain excellent accuracy performance, each transmitter is individually characterized over this ambient temperature range at the factory.

When using a Pt 100 ( $a = 0.00385$ ) sensor input with a 0–100 °C span at 30 °C ambient temperature:

- Temperature Effects:  $0.006 \text{ °C} \times (30 - 20) = 0.06 \text{ °C}$
- Calibration Temperature: 20° C

### Total transmitter error

- Worst case error: Transmitter error + temperature effects error =  $0.15 \text{ °C} + 0.06 \text{ °C} = 0.21 \text{ °C}$
- Total probable error:  $\sqrt{0.20^2 + 0.060^2} = 0.17 \text{ °C}$

---

#### Note

For additional information regarding total probable error (TPE), refer to the TPE White Paper.

---

# Product certifications

Rev: 1.15

## European Directive information

A copy of the EU Declaration of Conformity can be found at the end of the Quick Start Guide. The most recent revision of the EU Declaration of Conformity can be found at [Emerson.com/Rosemount](https://emerson.com/Rosemount).

## Ordinary location certification

As standard, the transmitter has been examined and tested to determine that the design meets the basic electrical, mechanical, and fire protection requirements by a Nationally Recognized Test Laboratory (NRTL) as accredited by the Federal Occupational Safety and Health Administration (OSHA).

## North America

The US National Electrical Code (NEC) and the Canadian Electrical Code (CEC) permit the use of Division marked equipment in Zones and Zone marked equipment in Divisions. The markings must be suitable for the area classification, gas, and temperature class. This information is clearly defined in the respective codes.

## USA

### E5 USA Explosionproof and Dust-Ignitionproof

**Certificate** 1091070

**Standards** FM Class 3600-2011, FM Class 3611-2004, FM Class 3615-2006, FM 3616-2011, UL Std. No. 60079-0: Ed.6, UL Std. No. 50E

**Markings** CL I/II/III, DIV 1, GP B, C, D, E, F, G; when installed per Rosemount drawing 00644-1059; Type 4X; IP66/68

### I5 USA Intrinsic Safety and Nonincendive

**Certificate** 1091070

**Standards** FM Class 3600-2011, FM Class 3610-2010, FM Class 3611-2004, UL Std. No. 60079-0: Ed.6, UL Std. No. 60079-11: Ed. 6, UL Std. No. 50E

**Markings** CL I/II/III, DIV 1, GP A, B, C, D, E, F, G; NI CL1, DIV 2, GP A, B, C, D when installed per Rosemount drawing 00248-1056; Type 4X; IP66/68

## Canada

### I6 Canada Intrinsically Safe

**Certificate** 1091070

**Standards** CAN/CSA C22.2 No. 0-10, CSA Std. C22.2 No. 25-1966, CAN/CSA C22.2 No. 94-M91, CAN/CSA C22.2 No. 157-92, CSA C22.2 No. 213-M1987, CAN/CSA C22.2 No. 60079-11:14, C22.2 No 60529-05

**Markings** IS CL I, DIV 1 GP A, B, C, D when installed per Rosemount drawing 00248-1056; CL I DIV 2 GP A, B, C, D; Type 4X; IP66/68

### K6 Canada Intrinsically Safe, Explosionproof, and Division 2

**Certificate** 1091070

**Standards** CAN/CSA C22.2 No. 0-10, CSA Std. C22.2 No. 25-1966, CSA Std. C22.2 No. 30-M1986, CAN/CSA C22.2 No. 94-M91, CSA Std. C22.2 No.142-M1987, CAN/CSA C22.2 No. 157-92, CSA C22.2 No. 213-M1987, CAN/CSA C22.2 No. 60079-11:14, C22.2 No 60529-05

**Markings** XP CL I/II/III, DIV 1, GP B, C, D, E, F, G when installed per Rosemount drawing 00644-1059; IS CL I, DIV 1 GP A, B, C, D when installed per Rosemount drawing 00248-1056; CL I DIV 2 GP A, B, C, D; Type 4X, IP66/68; Conduit Seal not required

## Europe

### E1 ATEX/UKEX Flameproof

**ATEX Certificate** DEKRA 19ATEX0076X

**UKEX Certificate** DEKRA 21UKEX0285X

**Standards** EN IEC 60079-0:2018, EN 60079-1:2014

**Markings**  II 2 G Ex db IIC T6...T1 Gb, T6(-60°C ≤ Ta ≤ +70°C), T5...T1(-60°C ≤ Ta ≤ +80°C);

#### Specific Conditions of Use (X):

1. Flameproof joints are not intended for repair.
2. Non-Standard Paint options may cause risk from electrostatic discharge. Avoid installations that cause electrostatic build-up on painted surfaces, and only clean the painted surfaces with a damp cloth. If paint is ordered through a special option code, contact the manufacturer for more information.

#### Additional Specific Condition of Use (X) when “XA” designation is ordered:

1. Guard DIN Style sensors against impacts greater than 4j.

Process temperature range at sensor connection <sup>(1)</sup> (°C)	Ambient temperature range (°C)	Temperature class
-60 °C to +70 °C	-60 °C to +70 °C	T6
-60 °C to +80 °C	-60 °C to +80 °C	T5...T1

(1) Sensor Connection is where the sensor threads into the transmitter or junction box housing.

### I1 ATEX Intrinsic Safety

**ATEX Certificate** Baseefa18ATEX0090X

**Standards** EN IEC 60079-0: 2018, EN 60079-11: 2012

**Markings**  II 1 G Ex ia IIC T5/T6 Ga, T5(-60°C ≤ Ta ≤ +80°C), T6(-60°C ≤ Ta ≤ +60°C)  
See Table P.C. 2 at the end of the Product Certifications section for Entity Parameters

#### Specific Conditions of Use (X):

The equipment, if supplied without an enclosure, must be installed in an enclosure which affords it a degree of protection of at least IP20. Non-metallic enclosures must have a surface resistance of less than 1GΩ; light alloy or zirconium enclosures must be protected from impact and friction if located in a Zone 0 environment.

### N1 ATEX Zone 2 - with enclosure

<b>Certificate</b>	Baseefa18ATEX0091X
<b>Standards</b>	EN IEC 60079-0:2018, EN 60079-15:2010
<b>Markings</b>	 II 3 G Ex nA IIC T5/T6 Gc, T5(-60°C ≤ Ta ≤ +80°C), T6(-60°C ≤ Ta ≤ +60°C);

### NC ATEX Zone 2 - without enclosure

<b>Certificate</b>	Baseefa18ATEX0091X
<b>Standards</b>	EN IEC 60079-0:2018, EN 60079-15:2010
<b>Markings</b>	 II 3 G Ex nA IIC T5/T6 Gc, T5(-60°C ≤ Ta ≤ +80°C), T6(-60°C ≤ Ta ≤ +60°C);

#### Specific Conditions of Use (X):

The equipment, if supplied without an enclosure, must be installed in a suitably certified enclosure such that it is afforded a degree of protection of at least IP54 in accordance with IEC 60529 and EN 60079-15 and be located in an area of pollution degree 2 or better as defined in IEC 60664-1.

### ND ATEX Dust-Ignitionproof

<b>ATEX Certificate</b>	DEKRA 19ATEX0076X
<b>Standards</b>	EN IEC 60079-0:2018, EN 60079-31:2014
<b>Markings</b>	 II 2 D Ex tb IIIC T130°C Db, (-60°C ≤ Ta ≤ +80°C)

#### Specific Condition of Safe Use (X):

Non-Standard Paint options may cause risk from electrostatic discharge. Avoid installations that cause electrostatic build-up on painted surfaces, and only clean the painted surfaces with a damp cloth. If paint is ordered through a special option code, contact the manufacturer for more information.

#### Additional Specific Condition of Use (X) when "XA" designation is ordered:

The spring loaded adapter style sensors and DIN style sensors must be installed in a thermowell to maintain Ex tb protection.

Process temperature range at sensor connection <sup>(1)</sup> (°C)	Ambient temperature range (°C)	Maximum surface temperature "T"
-60 °C to +80 °C	-60 °C to +80 °C	T130 °C

(1) *Sensor Connection is where the sensor threads into the transmitter or junction box housing.*

## International

### E7 IECEx Flameproof and Dust

<b>Certificate</b>	IECEX DEK 19.0041X
--------------------	--------------------

**Standards** IEC 60079-0:2017, IEC 60079-1:2014, IEC 60079-31:2013

**Markings** Ex db IIC T6...T1 Gb, T6(-60°C ≤ Ta ≤ +70°C), T5...T1(-60°C ≤ Ta ≤ +80°C); Ex tb IIIC T130°C Db, (-60°C ≤ Ta ≤ +80°C)

**Special Conditions for Safe Use (X):**

1. Flameproof joints are not intended for repair.
2. Non-Standard Paint options may cause risk from electrostatic discharge. Avoid installations that cause electrostatic build-up on painted surfaces, and only clean the painted surfaces with a damp cloth. If paint is ordered through a special option code, contact the manufacturer for more information.

**Additional Special Conditions for Safe Use (X) when “XA” designation is ordered:**

1. Guard DIN Style sensors against impacts greater than 4J.
2. The spring loaded adapter style sensors and DIN style sensors must be installed in a thermowell to maintain Ex tb protection.

Process temperature range at sensor connection <sup>(1)</sup> (°C)	Ambient temperature range (°C)	Temperature class / maximum surface temperature “T”
-60 °C to +70 °C	-60 °C to +70 °C	T6
-60 °C to +80 °C	-60 °C to +80 °C	T5...T1
-60 °C to +80 °C	-60 °C to +80 °C	T130 °C

(1) Sensor Connection is where the sensor threads into the transmitter or junction box housing.

**I7 IECEx Intrinsic Safety**

**Certificate** IECEx BAS 18.0062X

**Standards** IEC 60079-0:2017, IEC 60079-11:2011

**Markings** Ex ia IIC T5/T6 Ga, T5(-60°C ≤ Ta ≤ +80°C), T6(-60°C ≤ Ta ≤ +60°C); See Table P.C. 2 at the end of the Product Certifications section for Entity Parameters

**Specific Conditions of Use (X):**

The equipment, if supplied without an enclosure, must be installed in an enclosure which affords it a degree of protection of at least IP20. Non-metallic enclosures must have a surface resistance of less than 1GΩ; light alloy or zirconium enclosures must be protected from impact and friction if located in a Zone 0 environment.

**N7 IECEx Zone 2 – with enclosure**

**Certificate** IECEx BAS 18.0063X

**Standards** IEC 60079-0:2017, IEC 60079-15:2010

**Markings** Ex nA IIC T5/T6 Gc; T5(-60°C ≤ Ta ≤ +80°C), T6(-60°C ≤ Ta ≤ +60°C)

**NG IECEx Zone 2 – without enclosure**

**Certificate** IECEx BAS 18.0063X

**Standards** IEC 60079-0:2017, IEC 60079-15:2010

**Markings** Ex nA IIC T5/T6 Gc; T5(-60°C ≤ Ta ≤ +80°C), T6(-60°C ≤ Ta ≤ +60°C)

**Specific Conditions of Use (X):**

The equipment, if supplied without an enclosure, must be installed in a suitably certified enclosure such that it is afforded a degree of protection of at least IP54 in accordance with IEC 60529 and IEC 60079-15 and be located in an area of pollution degree 2 or better as defined in IEC 60664-1.

## Brazil

### E2 Brazil Flameproof and Dust-Ignitionproof

<b>Certificate</b>	UL-BR 13.0535X
<b>Standards</b>	ABNT NBR IEC 60079-0:2013, ABNT NBR IEC 60079-1:2016, ABNT NBR IEC 60079-31:2014
<b>Markings</b>	Ex db IIC T6...T1 Gb; T6...T1(-50°C ≤ Ta ≤ +40°C), T5...T1(-50°C ≤ Ta ≤ +60°C) Ex tb IIIC T130°C Db; IP66; (-40°C ≤ Ta ≤ +70°C)

**Special Conditions for Safe Use (X):**

1. See product description for ambient temperature limits and process temperature limits.
2. The non-metallic label may store an electrostatic charge and become a source of ignition in Group III environments.
3. Guard the LCD cover against impact energies greater than 4 joules.
4. Consult the manufacturer if dimensional information on the flameproof joints is necessary.
5. A suitable certified Ex "d" or Ex "tb" enclosure is required to be connected to temperature sensors with Enclosure option "N".
6. Care shall be taken by the end user to ensure that the external surface temperature on the equipment and the neck of the DIN Style Sensor does not exceed 130°C.
7. For all equipment, non-standard paint options may cause risk from electrostatic discharge. Avoid installation that cause electrostatic build-up on painted surfaces, and only clean the painted surfaces with a damp cloth. If paint is ordered through a special option code, contact the manufacturer for more information.

### I2 Brazil Intrinsic Safety

<b>Certificate</b>	UL-BR 19.0202X
<b>Standards</b>	ABNT NBR IEC 60079-0:2013, ABNT NBR IEC 60079-11:2013
<b>Markings</b>	Ex ia IIC T5 Ga (-60°C ≤ Ta ≤ +80°C) Ex ia IIC T6 Ga (-60°C ≤ Ta ≤ +60°C) See Table P.C. 2 at the end of the Product Certifications section for Entity Parameters

**Special Conditions for Safe Use (X):**

The equipment, if supplied without an enclosure, must be installed in an enclosure which affords it a degree of protection of at least IP20. Non-metallic enclosures must have a surface resistance of less than 1GΩ; light alloy or zirconium enclosures must be protected from impact and friction when installed if located in a Zone 0 environment (areas that required EPL Ga).

### N2 Brazil Zone 2

<b>Certificate</b>	UL-BR 19.0203X
<b>Standards</b>	ABNT NBR IEC 60079-0:2013, ABNT NBR IEC 60079-15:2012

**Markings** Ex nA IIC T5 Gc (-60°C ≤ Ta ≤ +80°C)  
Ex nA IIC T6 Gc (-60°C ≤ Ta ≤ +60°C)

### Special Condition for Safe Use (X):

The equipment, if supplied without an enclosure, must be installed in a suitably certified enclosure such that it is afforded a degree of protection of at least IP54 in accordance with ABNT NBR IEC 60529 and ABNT NBR IEC 60079-15 and be located in an area of pollution degree 2 or better as defined in IEC 60664-1.

## China

### E3 China Flameproof

**Certificate** GYJ21.1275X  
**Standards** GB3836.1-2010, GB3836.2-2010  
**Markings** Ex d IIC T6~T1 Gb: T6(-60°C ≤ Ta ≤ +70°C) T5~T1 (-60°C ≤ Ta ≤ +80°C)

- 产品安全使用特殊条件  
证书编号后缀“X”表明产品具有安全使用特殊条件：涉及隔爆接合面的维修须联系产品制造商。
- 产品使用注意事项
  1. 产品使用环境温度与温度组别的关系为：

温度组别	环境温度
T6	-60°C ≤ Ta ≤ + 70°C
T5~T1	-60°C ≤ Ta ≤ + 80°C

2. 产品外壳设有接地端子，用户在使用时应可靠接地。
3. 安装现场应不存在对产品外壳有腐蚀作用的有害气体。
4. 现场安装时，电缆引入口须选用国家指定的防爆检验机构按检验认可、具有 Ex dIIC 防爆等级的电缆引入装置或堵封件，冗余电缆引入口须用堵封件有效密封。
5. 现场安装、使用和维护必须严格遵守“断电后开盖！”的警告语。  
用户不得自行更换该产品的零部件，应会同产品制造商共同解决运行中出现的故障，以杜绝损坏现象的发生。  
产品的安装、使用和维护应同时遵守产品使用说明书、GB3836.13-2013“爆炸性环境 第 13 部分：设备的修理、检修、修复和改造”、GB3836.15-2000“爆炸性气体环境用电气设备 第 15 部分：危险场所电气安装（煤矿除外）”、GB3836.16-2006“爆炸性气体环境用电气设备 第 16 部分：电气装置的检查和维护（煤矿除外）”和 GB50257-2014 “电气装置安装工程爆炸和火灾危险环境电力装置施工及验收规范”的有关规定。

### I3 China Intrinsic Safety

**Certificate** GYJ19.1126X  
**Standards** GB3836.1-2010, GB3836.4-2010, GB3836.20-2010  
**Markings** Ex ia IIC T5/T6 Ga; T6(-60°C ≤ Ta ≤ +60°C) T5(-60°C ≤ Ta ≤ +80°C)  
See Table P.C. 2 at the end of the Product Certifications section for Entity Parameters

### Special Conditions for Safe Use (X):

See certificate for special conditions.



## N3 China Zone 2

<b>Certificate</b>	GYJ19.1127
<b>Standards</b>	GB3836.1-2010, GB3836.8-2014
<b>Markings</b>	Ex nA IIC T5/T6 Gc; T6(-60°C ≤Ta≤+60°C) T5(-60°C ≤Ta≤+80°C); Vmax = 42.4Vdc

### Special Conditions for Safe Use (X):

See certificate for special conditions.

## EAC

### EM Technical Regulation Customs Union (EAC) Flameproof

<b>Markings</b>	1Ex d IIC T6...T1 Gb X, T6(-50°C ≤Ta ≤+40°C), T5...T1(-50°C ≤Ta ≤+60°C); IP66/IP68
-----------------	--

### Special Condition for Safe Use (X):

See certificate for special conditions.

### IM Technical Regulation Customs Union (EAC) Intrinsic Safety

<b>Markings</b>	0Ex ia IIC T6...T5 Ga X, T6(-60°C ≤Ta ≤+60°C), T5(-60°C ≤Ta ≤+80°C); IP66/IP68
-----------------	--

### Special conditions for safe use (X):

See certificate for special conditions.

### KM Technical Regulation Customs Union TR CU 012/2011 (EAC) Flameproof, Intrinsic Safety, and Dust-Ignitionproof

<b>Markings</b>	Ex tb IIIC T130°C Db X (-40°C ≤ Ta ≤ +70°C); IP66/IP68 See <a href="#">EM</a> for Flameproof Markings and see <a href="#">IM</a> for Intrinsic Safety Markings.
-----------------	--

### Special conditions for safe use (X):

See certificate for special conditions.

## Korea

### EP Korea Explosionproof/Flameproof

<b>Certificate</b>	22-KB4BO-0078X
<b>Markings</b>	Ex db IIC T6...T1 Gb; T6 (-60°C ≤ T <sub>amb</sub> ≤ +70°C); T5...T1 (-60°C ≤ T <sub>amb</sub> ≤ +80°C)

### Special Conditions for Safe Use (X):

See certificate for special conditions.

## Combinations

- K1**      Combination of E1, I1, N1 and ND
- K5**      Combination of E5 and I5
- K6**      Combination of I6 and Canada Explosionproof
- K7**      Combination of E7, I7 and N7
- KM**     Combination of EM and IM with Dust

## Tables

**Table 4: Table P.C. 1: Process Temperatures**

Temperature Class	Ambient Temperature	Process Temperature w/o LCD Cover (°C)			
		No ext.	3"	6"	9"
T6	-50°C to +40°C	55	55	60	65
T5	-50°C to +60°C	70	70	70	75
T4	-50°C to +60°C	100	110	120	130
T3	-50°C to +60°C	170	190	200	200
T2	-50°C to +60°C	280	300	300	300
T1	-50°C to +60°C	440	450	450	450
T130°C	-40°C to +70°C	100	110	110	120

**Table 5: Table P.C. 2: Entity Parameters**

	HART loop terminals + and -	Sensor terminals 1 to 4
Voltage $U_i$	30 V	30 V
Current $I_i$	266 mA	26 mA
Power $P_i$	1 W	191 mW
Capacitance $C_i$	0 nF	1.54 nF
Inductance $L_i$	0 mH	0 $\mu$ H

## Additional certifications (248 Head Mount only)

### SBS

**American Bureau of Shipping (ABS) Type Approval Certificate:** 21-2157987-PDA

**Intended Use:** Measurement of temperature for marine and offshore applications

### SBV

**Bureau Veritas (BV) Type Approval Certificate:** 26325

**Requirements:** Bureau Veritas Rules for the Classification of Steel Ships

**Application:** Class notations: AUT-UMS, AUT-CCS, AUT-PORT and AUT-IMS; Temperature transmitter cannot be installed on diesel engines

**SDN**

**Det Norske Veritas (DNV) Type Approval Certificate:** TAA00000K8

**Intended Use:** Det Norske Veritas’ Rules for Classification of Ships, High Speed & Light Craft and Det Norske Veritas’ Offshore Standards

**Application:** **Table 6: Location Classes**



Temperature	D
Humidity	B
Vibration	A
EMC	A
Enclosure	B/IP66 AI C/IP66: SST

**SLL**

**Lloyds Register (LR) Type Approval Certificate:** LR21173788TA

**Application:** Environmental categories ENV1, ENV2, ENV3, and ENV5

### Declaration of Conformity

## EU Declaration of Conformity

No: RMD 1134 Rev. D

---

We,

**Rosemount Inc.**  
6021 Innovation Boulevard  
Shakopee, MN 55379-4676  
USA

declare under our sole responsibility that the product,

**Rosemount™ 248H Temperature Transmitter**

manufactured by,

**Rosemount Inc.**  
6021 Innovation Boulevard  
Shakopee, MN 55379-4676  
USA

to which this declaration relates, is in conformity with the provisions of the European Union Directives, including the latest amendments, as shown in the attached schedule.

Assumption of conformity is based on the application of the harmonized standards and, when applicable or required, a European Union notified body certification, as shown in the attached schedule.



\_\_\_\_\_  
(signature)

Mark Lee  
\_\_\_\_\_  
(name)

Vice President of Global Quality  
\_\_\_\_\_  
(function)

October 22, 2021  
\_\_\_\_\_  
(date of issue)

Page 1 of 3



## EU Declaration of Conformity

No: RMD 1134 Rev. D

### EMC Directive (2014/30/EU)

Rosemount [Model Number & Description]

Harmonized Standards: EN61326-1:2013, EN61326-2-3:2013

### ATEX Directive (2014/34/EU)

Rosemount 248 Temperature Transmitter

#### Baseefa18ATEX0090X – Intrinsic Safety Certificate

Equipment Group II, Category 1 G

Ex ia IIC T5/T6 Ga

Harmonized Standards:

EN IEC 60079-0:2018, EN 60079-11:2012

#### Baseefa18ATEX0091X – Zone 2 Certificate

Equipment Group II, Category 3 G

Ex nA IIC T5/T6 Gc

Harmonized Standards:

EN IEC 60079-0:2018, EN 60079-15:2010

#### DEKRA 19ATEX0076 X – Flameproof Certificate

Equipment Group II, Category 2 G

Ex db IIC T6...T1 Gb

Harmonized Standards:

EN IEC 60079-0:2018, EN 60079-1:2014

#### DEKRA 19ATEX0076 X – Dust Certificate

Equipment Group II, Category 2 D

Ex tb IIC T130°C Db

Harmonized Standards:

EN IEC 60079-0:2018, EN 60079-31:2014

### RoHS Directive (2011/65/EU)

Harmonized Standard:

EN 50581:2012



## EU Declaration of Conformity

No: RMD 1134 Rev. D

### ATEX Notified Bodies

**Dekra Certification B.V.** [Notified Body Number: 0344]  
Utrechtseweg 310  
Postbus 5185  
6802 ED Arnhem  
Netherlands

**SGS FIMKO OY** [Notified Body Number: 0598]  
Takomotie 8  
00380 HELSINKI  
Finland

### ATEX Notified Body for Quality Assurance

**SGS FIMKO OY** [Notified Body Number: 0598]  
Takomotie 8  
00380 HELSINKI  
Finland

## China RoHS

含有 China RoHS 管控物质超过最大浓度限值的部件型号列表 248  
List of 248 Parts with China RoHS Concentration above MCVs

部件名称 Part Name	有害物质 / Hazardous Substances					
	铅 Lead (Pb)	汞 Mercury (Hg)	镉 Cadmium (Cd)	六价铬 Hexavalent Chromium (Cr +6)	多溴联苯 Polybrominated biphenyls (PBB)	多溴联苯醚 Polybrominated diphenyl ethers (PBDE)
电子组件 Electronics Assembly	X	○	○	○	○	○
壳体组件 Housing Assembly	○	○	○	X	○	○
传感器组件 Sensor Assembly	X	○	○	○	○	○

本表格系依据 SJ/T11364 的规定而制作。

This table is proposed in accordance with the provision of SJ/T11364.

○: 意为该部件的所有均质材料中该有害物质的含量均低于 GB/T 26572 所规定的限量要求。

○: Indicate that said hazardous substance in all of the homogeneous materials for this part is below the limit requirement of GB/T 26572.

X: 意为在该部件所使用的所有均质材料里，至少有一类均质材料中该有害物质的含量高于 GB/T 26572 所规定的限量要求。

X: Indicate that said hazardous substance contained in at least one of the homogeneous materials used for this part is above the limit requirement of GB/T 26572.

部件名称 Part Name	组装备件说明 Spare Parts Descriptions for Assemblies
电子组件 Electronics Assembly	电子线路板组件 Electronic Board Assemblies 端子块组件 Terminal Block Assemblies
壳体组件 Housing Assembly	电子外壳 Electrical Housing



# Dimensional drawings

Figure 4: Transmitters

Rosemount 248H headmount (enlarged)

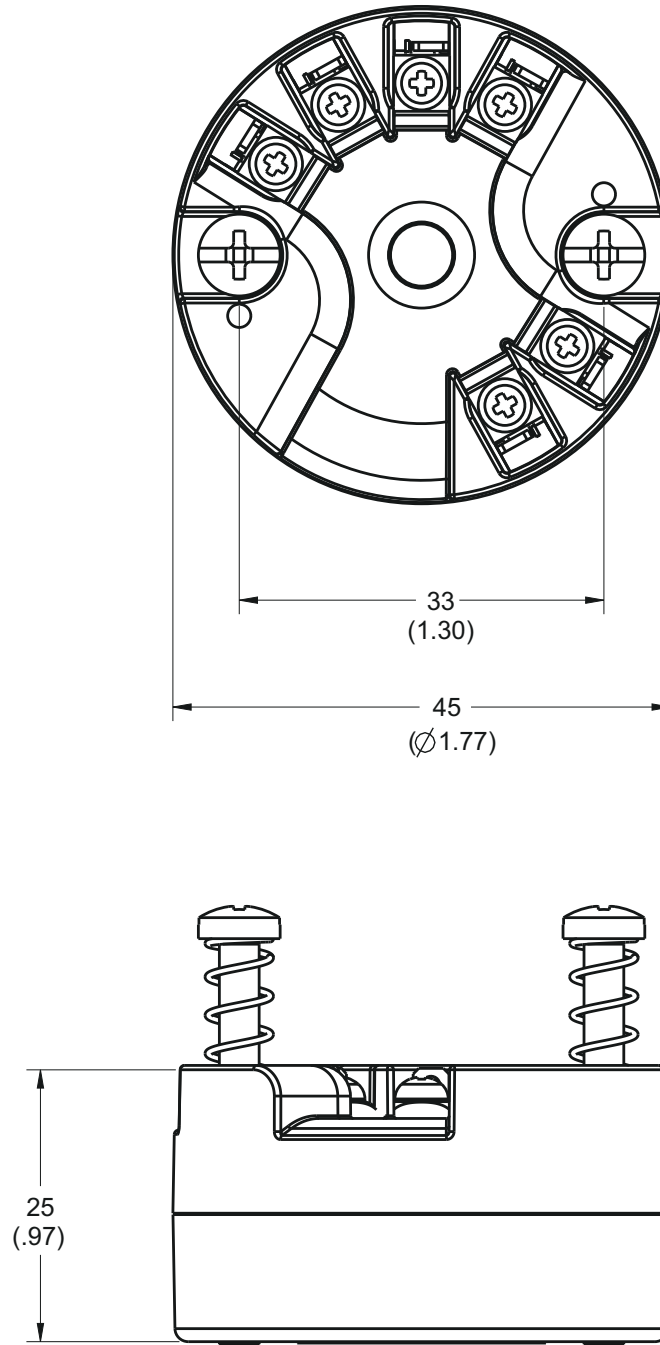

**Note**  
Dimensions are in millimeters (inches).



Figure 5: Enclosures

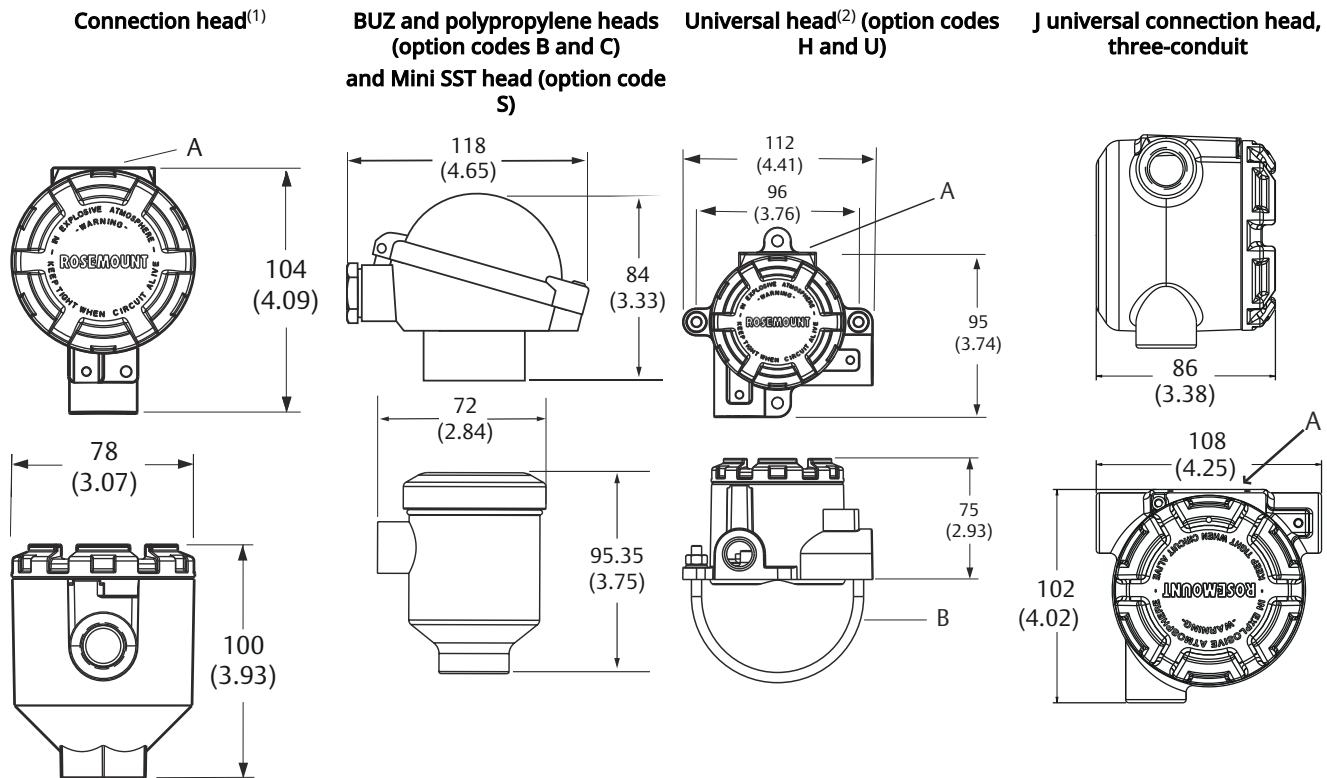

A. Approval label

B. SST "U" bolt mounting, 2-in. pipe

Dimensions are in millimeters (inches).

- (1) If ordering the transmitter with a DIN style sensor, then it is recommended the enclosure be ordered within the sensor model (see Rosemount DIN-Style [Product Data Sheet](#)) rather than within the transmitter model. This is in order to drive necessary parts.
- (2) A U-bolt is shipped with each universal head unless a sensor is ordered assembled to the enclosure. However, since the head can be integrally mounted to the sensor, it may not need to be used.

## Configuration interface specifications

### Configuration software

#### Note

The Rosemount configuration software is compatible with Windows™ XP, Windows 7 32-bit and Windows 7 64-bit. It is not compatible with Windows NT and Windows 2000. The PC-based configuration software is only available for HART Revision 5 output.

The Rosemount 248 PC-based configuration software for the Rosemount 248 allows comprehensive configuration of the transmitters. When used in conjunction with various Rosemount or user-supplied hardware modems, the software provides the tools necessary to configure the Rosemount 248 Transmitters. This includes the following parameters:

- Process variable
- Sensor type
- Number of wires
- Engineering units

- Transmitter tag information
- Damping
- Alarming parameters

## Configuration hardware (HART® 5 only)

The Rosemount 248 Configuration Interface has three hardware options as follows:

### Software only

- Part number: 00248-1603-0002
- Customer must provide appropriate communications hardware (e.g. modem, power supply).

### Serial HART modem and software

- Part number: 00248-1603-0004
- Serial HART modem
- Customer must provide separate loop power supply and resistor.
- Requires PC serial port
- Suitable for use with powered loops

### USB HART modem and software

- Part number: 00248-1603-0003
- USB (Universal Serial Bus) HART modem
- Customer must provide separate loop power supply and resistor.
- Requires PC with USB port
- Suitable for use with powered loops

## Transmitter accessories

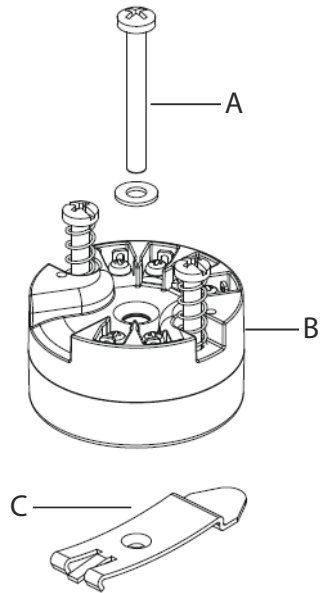

- A. Mounting hardware
- B. Transmitter
- C. Rail clip

**Table 7: Transmitter Accessories**

Part description	Part number
Aluminum alloy universal head – M20 entries	00644-4420-0002
Aluminum alloy Universal Head – ½ NPT entries	00644-4420-0001
Aluminum alloy Rosemount connection head – M20 Conduit entry, M24 Instrument entry	00644-4410-0023
Aluminum alloy Rosemount connection head – ½ NPT Conduit entry and M24 Instrument entry	00644-4410-0013
Aluminum alloy BUZ head – M20 Conduit entry, M24 Instrument entry	00644-4196-0023
Aluminum alloy BUZ head – M20 Conduit entry and ½ NPT Instrument entry	00644-4196-0021
Aluminum alloy BUZ head – ½ NPT Conduit entry	00644-4196-0011
Universal head, aluminum, standard cover, 3-Conduit - M20 Entries	00644-4439-0001
Universal head, aluminum, standard cover, 3-Conduit - ½ - 14 NPT Entries	00644-4439-0002
External ground screw assembly kit	00644-4431-0001
Kit, hardware for mounting a Rosemount 248 to a DIN rail (see left picture-top hat rail, symmetric)	00248-1601-0001
Standard cover for universal or Rosemount connection heads	03031-0292-0001
Snap rings kit (used for assembly to DIN plate style sensor)	00644-4432-0001
Rosemount 248 programming software (CD)	00248-1603-0002
Rosemount 248 programming kit - Serial connection	00248-1603-0004
Rosemount 248 programming kit - USB connection	00248-1603-0003

## Hardware tag

- 20 characters maximum

- Transmitter enclosure, sensor, and thermowell if applicable will be tagged in accordance with customer requirements.

### Software tag

- The transmitter can store up to eight characters. If no characters are specified, then the first eight characters of the hardware tag are the default.
- Long software tag available with HART 7 up to 32 characters.

### Configuration

When ordering a transmitter and sensor assembly in one model number, the transmitter will be configured for the sensor that is ordered.

When a transmitter is ordered alone, the transmitter will be shipped as follows (unless specified):

Sensor type	RTD, Pt 100 ( $\alpha=0.00385$ , 4-wire)
4 mA Value	0 °C
20 mA Value	100 °C
Damping	5 seconds
Output	Linear with temperature
Failure Mode	High/Upscale
Line Voltage Filter	50 Hz
Tag	See <a href="#">Hardware tag</a>

### Options

The following table lists the requirements necessary to specify a custom configuration.

Option code	Requirements/Specification
C1: Factory configuration data (CDS required)	Date: day/month/year Descriptor: 16 alphanumeric characters Message: 32 alphanumeric character Analog Output: Alarm and saturation levels
A1: NAMUR-compliant, high alarm	See <a href="#">NAMUR recommendations</a> .
CN: NAMUR-compliant, low alarm	See <a href="#">NAMUR recommendations</a> .
Q4: Calibration certificate	Will include 3-point calibration at 0, 50, and 100% analog and digital output points.
C4: 5-point calibration	Will include 5-point calibration at 0, 25, 50, 75, and 100% analog and digital output points. Use with Calibration Certificate Q4.
F6: 60 Hz Line Filter	Calibrated to a 60 Hz line voltage filter instead of 50 Hz filter







For more information: [Emerson.com/global](https://emerson.com/global)

©2023 Emerson. All rights reserved.

Emerson Terms and Conditions of Sale are available upon request. The Emerson logo is a trademark and service mark of Emerson Electric Co. Rosemount is a mark of one of the Emerson family of companies. All other marks are the property of their respective owners.